



Ersatzteilliste Grubbermat
Parts book Cultivator Grubbermat
Pièces de rechange Grubbermat



Köckerling GmbH & Co. KG
Lindenstraße 11-13
33415 Verl
Telefon: (+49) 5246 9608-0
Fax: (+49) 5246 9608-21
Internet: www.koeckerling.de
e-mail: info@koeckerling.de

Inhaltsverzeichnis

Content

Seite

Page

Schare	<i>Points</i>	<i>Socs</i>	1
SGF - Einheit	<i>Tine adjustment</i>	<i>Support de tige</i>	1
Blattfederzinken	<i>Tine</i>	<i>Tige</i>	2
Anhängung	<i>Drawbar-head</i>	<i>Tête d'attelage</i>	3
Nivellator	<i>Leveller</i>	<i>Niveleur</i>	3
Beleuchtung	<i>Lightening</i>	<i>Eclairage</i>	4
STS Walze	<i>STS roller</i>	<i>STS rouleau</i>	5
Krümlerwalze	<i>Roller</i>	<i>Rouleau</i>	7
Nachstriegel	<i>Seedbed tine</i>	<i>Peigne</i>	8
Anbauarm	<i>Arm for roller</i>	<i>Bras pour rouleau</i>	10
Stützrad	<i>Depth wheel</i>	<i>Roue de profondeur</i>	11
Hydraulikplan	<i>Hydraulic plan</i>	<i>Plan d'hydraulique</i>	12



Pos.	Art. Nr.	Bezeichnung
1	900863	Flachschar 450mm
1	900863	Flachschar 450mm
2	506019	Gänsefußschar
2	506019	Gänsefußschar
3	506202	Senkkopfschraube M12 x 65mm
3	506202	Bolt M12 x 65mm
4	901626	Sperrkantscheibe 12
4	901626	Washer 12
5	901618	Mutter M12 DIN 980
5	901618	Nut M12
6a	901618	Mutter M12
6a	901618	Nut M12
6b	901620	Mutter M16 Din 980
6b	901620	Nut M16
7	901655	Schwerspannstift 20 x 26mm roh
7	901655	Roll pin 20 x 26mm
8a	901718	Sechskantschraube M12 x 65mm 10.9
8a	901718	Bolt M12 x 65mm 10.9
8b	901549	Sechskantschraube M16x70mm
8b	901549	Bolt M16x70mm
9	901622	Mutter M20
9	901622	Nut M20
10	506056	Sechskantschraube M20 x 70mm
10	506056	Bolt M20 x 70mm
11	506051	Scharstiel 60 x 25mm
11	506051	Tine 60 x 25mm
12	506033	Breitschar 100 x 12mm
12	506033	Points 100 x 12mm
13	506101	1-teiliges Flügelschar 450mm
13	506101	1-teiliges Flügelschar 450mm
14	506204	Senkkopfschraube M12 x 75mm
14	506204	Bolt M12 x 75mm
15	084246	Unterschwinge
15	084246	Lower section of tine holder
16	506072	Druckfeder 480
16	506072	Spring 480
17	901610	Mutter M24
17	901610	Nut M24
18	901674	Tellerfeder 50 x 25mm
18	901674	Bevelle washer 50 x 25mm
19	900866	Führungsbuchse
19	900866	Nylon washer
20	084244	SGF-Verbindungsspindel
20	084244	Turnbuckle
21	506073	Aufnahme Trägerarm zum Anschweißen
21	506073	Lower section of tine holder

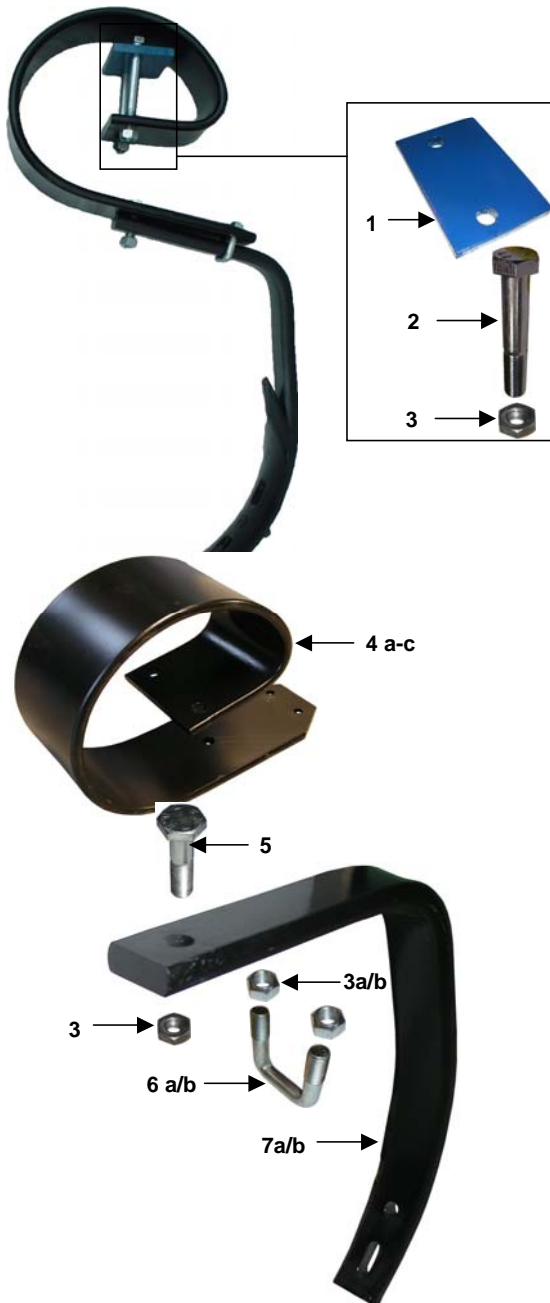

Pos.	Art. Nr.	Bezeichnung
1	506216	Befestigungsplatte 90 x 15 x 140mm
1	506216	Plate 90 x 15 x 140mm
2	901728	Sechskantschraube M16 x 150 ohne Mutter
2	901728	Bolt M16 x 150
3a	901620	Mutter M16
3a	901620	Nut M16
3b	901618	Mutter M12 DIN 980
3b	901618	Nut M12
4a	506207	Oberfeder 150mm x 16mm
4a	506207	Tine spring 150 x 16mm
4b	506208	Oberfeder 150mm x 14mm
4b	506208	Tine spring 150mm x14mm
5	901501	Sechskantschraube M16 x 60 10.9 ohne Mutter
5	901501	Bolt M16 x 60
6a	900798	Bügelschraube M12x51x55 ohne Mutter
6a	900798	U-Bolt M12 x 51 x 55
6b	904263	Bügelschraube M16 x 50 x 65mm ohne Mutter (ab 04/2004)
6b	904263	U-Bolt M16 x 50 x 65mm (since 04/2004)
7a	506211	Blattfederzinkenunterteil 50x26mm L=650mm (Serie ab1998 bis 04/2004)
7a	506211	Tine, lower leg 50x26mm L=650mm (since 1998 until 04/2004)
7b	506210	Blattfederzinkenunterteil 50x22mm L=570mm
7b	506210	Tine, lower leg 50x22mm L=570mm
8	500110	Oberlenkerbolzen 25/32mm Kat II u. III
8	500110	Pin 25/32mm Kat II and III
9	500112	Unterlenkerbolzen 28/36mm Kat II u. III
9	500112	Pin 28/36 Kat II and III

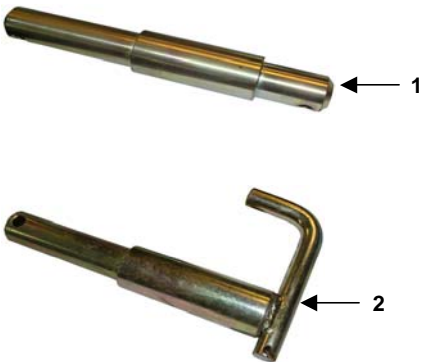

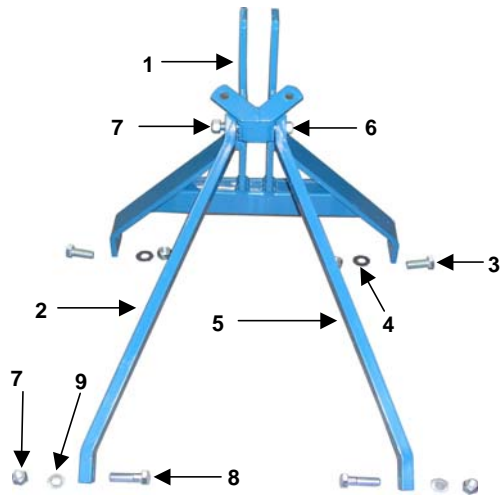

Pos.	Art. Nr.	Bezeichnung
1	506242	Dreipunkturm o. Strebe
1	506242	3-point-linkage
2	084290	Turmstrebe
2	084290	Support for 3-point-linkage
3	901598	Sechskantschraube M24 x 60mm
3	901598	Bolt M24 x 60mm
4	901674	Tellerfeder 50 x 25,4 x 3mm
4	901674	Washer 50 x 25,4 x 3mm
5	901624	Mutter M24
5	901624	Nut M24
6	901740	Sechskantschraube M20 x 160mm
6	901740	Bolt M20 x 160mm
7	901622	Mutter M20
7	901622	Nut M20
8	506056	Sechskantschraube M20 x 70mm
8	506056	Bolt M20 x 70mm
9	901630	Kontaktscheibe 20mm
9	901630	Washer
10	506224	Sechskantschraube M12 x 100mm
10	506224	Bolt M12 x 100mm
11	506222	Befestigungsplatte 80 x 10mm
11	506222	Plate
12	901618	Mutter M12
12	901618	Nut M12
13	506220	Blattfedernivellatorzinken links 60 x 10mm
13	506220	Leveller left 60x10mm
14	506219	Blattfedernivellator rechts 60 x 10mm
14	506219	Leveller right

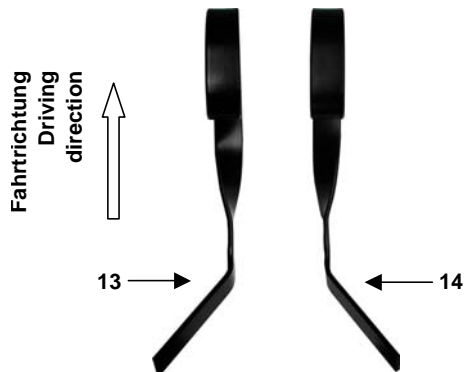
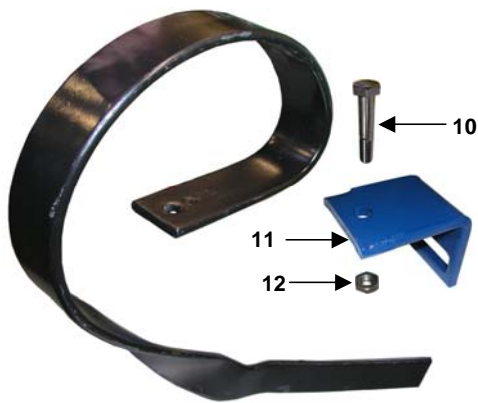

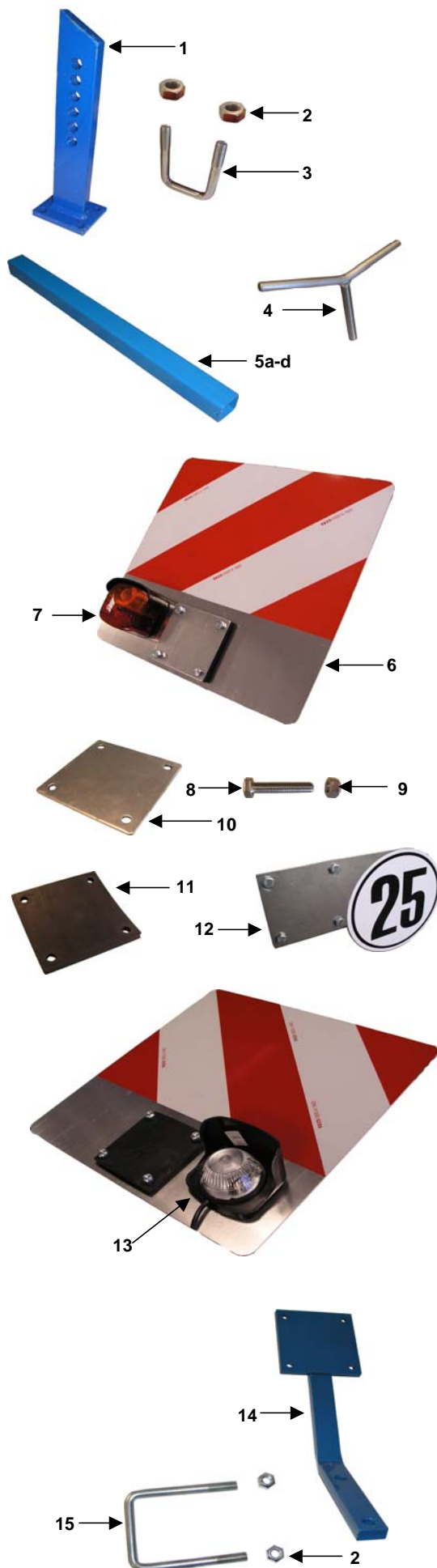

Pos.	Art. Nr.	Bezeichnung
1	506281	Einschubstück für Blattfedernivellator
1	506281	Adjustable bracket
1	506281	Rallonge
2	901618	Mutter M12
2	901618	Nut M12
2	901618	Ecrout M12
3	900842	Bügelschraube 12 x 61 x 95mm
3	900842	U-Bolt 12 x 61 x 95mm
3	900842	Bride 12 x 61 x 95mm
4	632332	Klemmschraube Einschubrohr
4	632332	Bolt for leveller
4	632332	Vis p. niveleur
5a	506 233	Nivellatoreinschubrohr
5a	506 233	Tube for leveller
5a	506 233	Tuyau niveleur
5b	632 472	Nivellatorrohr einseitig einziehbar 1600mm
5b	632 472	Tube for leveller 1600mm
5b	632 472	Tuyau niveleur 1600mm
5c	632 072	Nivellatorrohr einseitig einziehbar 2050mm
5c	632 072	Tube for leveller 2050mm
5c	632 072	Tuyau niveleur 2050mm
5d	631 180	Nivellatorrohr 2800 beidseitig einziehbar
5d	631 180	Tube for leveller 2800mm
5d	631 180	Tuyau niveleur 2800mm
6	903200	Satz Warntafeln mit Beleuchtung Koecker 6
6	903200	Lightening set
6	903200	Panneau avec feux de signalisation cpl. Koecker 6
7	903641	Lichtscheibe rot/gelb
7	903641	Brake light
7	903641	Signal lumineux rouge
8	901743	Sechskantschraube M10x40mm
8	901743	Bolt M10x40mm
8	901743	Vis M10x40mm
9	901617	Mutter M10 Din 934
9	901617	Nut M10
9	901617	Ecrou M10 Din 934
10	904378	Beleuchtungsblech
10	904378	Plate
10	904378	Plaque d'éclairage
11	904382	Puffer
11	904382	Rubber
11	904382	Bouchon
12	904624	Beleuchtungsblech "25 Km/h"
12	904624	Plate
12	904624	Plaque d'éclairage
13	903342	Beleuchtungsscheibe weiß
13	903342	Lightening glas white
13	903342	Signal lumineux blanche
14	631480	Beleuchtungshalter
14	631480	Lightening plate
14	631480	Support rampe d'éclairage
15	900970	Bügelschraube M12 x 81 x 110mm
15	900970	U-Bolt M12 x 81 x 110mm
15	900970	Bride M12 x 81 x 110mm

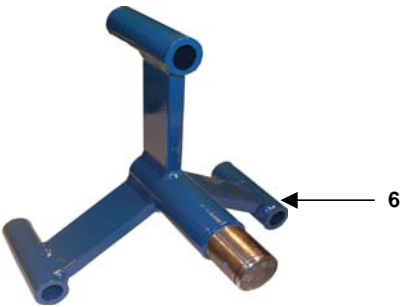
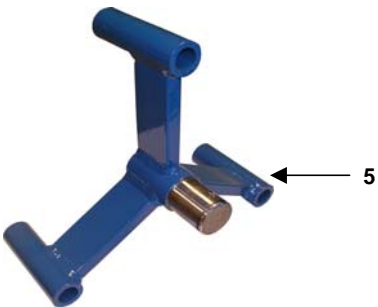
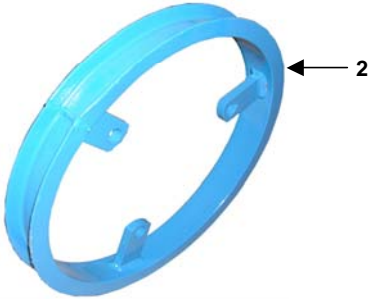
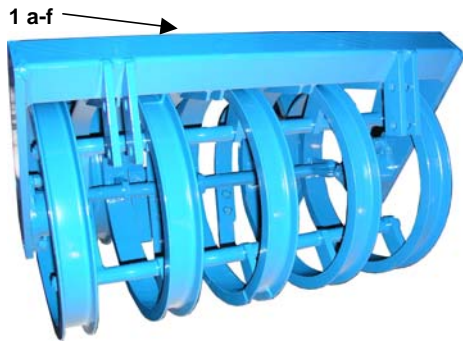

Pos.	Art. Nr.	Bezeichnung
1a	085100	Rahmen STS 5 Ringe
1a	085100	Frame STS
1b	085120	Rahmen STS 7 Ringe
1b	085120	Frame STS
1c	080530	Rahmen STS 8 Ringe
1c	080530	Frame STS
1d	086102	Rahmen STS 16 Ringe
1d	086102	Frame STS
1e	631820	Rahmen STS 17 Ringe
1e	631820	Frame STS
1f	085130	Rahmen STS 23 Ringe
1f	085130	Frame STS
2	084252	STS Ring
2	084252	STS Ring
3a	085140	Gewindestindel M20 x 775mm (5 Ringe)
3a	085140	Rod M20 x 775mm
3b	085150	Gewindestindel M20 x 1135mm (7 Ringe)
3b	085150	Rod M20 x 1135mm
3c	084258	Gewindestindel M20 x 1315mm (8 Ringe)
3c	084258	Rod M20 x 1315mm
3d	085160	Gewindestindel M20 x 1495mm (9 Ringe)
3d	085160	Rod M20 x 1495mm
3e	085170	Gewindestindel M20 x 1855mm (11 Ringe)
3e	085170	Rod M20 x 1855mm
3f	085180	Gewindestindel M20 x 2035mm (12 Ringe)
3f	085180	Rod M20 x 2035mm
4	901622	Mutter M20 Din 980
4	901622	Nut M20
5	084254	Lagerkreuz kurz
5	084254	Cross
6	084256	Lagerkreuz lang
6	084256	Roller-end-cross long
7	085262	Hülse L=165mm
7	085262	Wear part for STS
8	86263	Lagerkreuzhülse L=50mm
8	86263	Wear part STS short

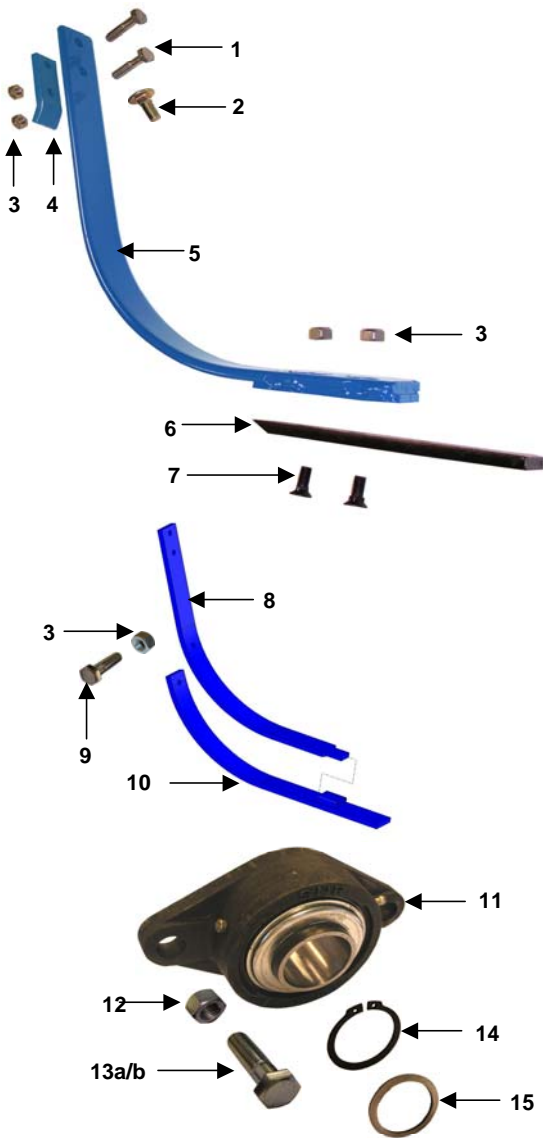

Pos. Art. Nr. Bezeichnung
900920 Zwischenfeder kpl. m. Verschleißteil
900920 Spring part cpl. with wear part
900920 Ressort avec pièce d'usure cpl.

- 1 901745 Sechskantschraube M10 x 45mm
- 1 901745 Bolt M10 x 45mm
- 1 901745 Vis M10 x 45mm
- 2 901798 Flachrundschraube M12x30mm
- 2 901798 Bolt M12x30mm
- 2 901798 Vis M12x30mm
- 3 901617 Mutter M10
- 3 901617 Nut M10
- 3 901617 Ecrout M10
- 4 080539 Montageplatte
- 4 080539 Plate
- 4 080539 Plaque
- 5 080538 Zwischenfeder 45 x 10mm
- 5 080538 Spring part 45 x 10mm
- 5 080538 Ressort 45 x 10mm
- 6 900909 Verschleißteil
- 6 900909 Wear part
- 6 900909 Pièce d'usure
- 7 901517 Senkkopfschraube M10 x 25mm
- 7 901517 Bolt M10 x 25mm
- 7 901517 Vis M10 x 25mm
- 8 904478 Zwischenfeder 06
- 8 904478 Spring part 06
- 8 904478 Ressort 06

633236 Zwischenfeder 06 kpl. m. Verschleißstück
633236 Spring part 06 cpl. with wear part
633236 Ressort 06 avec pièce d'usure cpl.

- 9 901575 Sechskantschraube M10x30mm
- 9 901575 Bolt M10x30mm
- 9 901575 Vis M10x30mm
- 10 633238 Verschleißteil Zwischenfeder 06
- 10 633238 Wear part Spring part 06
- 10 633238 Pièce d'usure Ressort 06
- 11 567148 Lager kpl. mit Gehäuse
- 11 567148 Bearing with Housing
- 11 567148 Roulement complet avec palier



- 12 901620 Mutter M16 Din 980
- 12 901620 Nut M16
- 12 901620 Ecrout M16
- 13a 901548 Sechskantschraube M16 x 60mm
- 13a 901548 Bolt M16 x 60mm
- 13a 901548 Vis M16 x 60mm
- 13b 901755 Senkkopfschraube M16 x 45mm
- 13b 901755 Bolt M16 x 45mm
- 13b 901755 Vis 16 x 45mm
- 14 901703 Sicherungsring A40
- 14 901703 Ring
- 14 901703 Circlips
- 15 901773 Stützscheibe 40 x 50 x 2,5mm
- 15 901773 Washer 40 x 50 x 2,5mm
- 15 901773 Rondelle 40 x 50 x 2,5mm



- 16 080390 Brücke 40 x 20 x 137mm
- 16 080390 Plate 40 x 20 x 137mm
- 16 080390 Plaque 40 x 20 x 137mm
- 17 901558 Sechskantschraube M16 x 140mm
- 17 901558 Bolt M16 x 140mm
- 17 901558 Vis M16 x 140mm

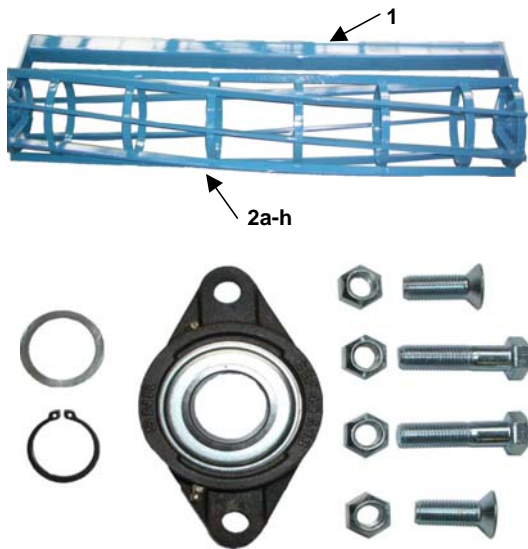

Teilenummern siehe STS-Walze

Pos.	Art. Nr.	Bezeichnung
1	506237	Krümerrahmen (Bitte Arbeitsbreite Grubber angeben)
1	506237	Frame for roller
2a	506 301	Krümlerwalze Ø450 mm 1,00 m (ohne Lager, ohne Rahmen)
2a	506 301	Roller Ø450 mm 1,00m (without frame, without bearing)
2b	506 303	Krümlerwalze Ø450 mm 1,30 m (ohne Lager, ohne Rahmen)
2b	506 303	Roller Ø450 mm 1,30m (without frame, without bearing)
2c	506 285	Krümlerwalze Ø450 mm 1,40 m (ohne Lager, ohne Rahmen)
2c	506 285	Roller Ø450 mm 1,40m (without frame, without bearing)
2d	506 312	Krümlerwalze Ø450 mm 1,80 m (ohne Lager, ohne Rahmen)
2d	506 312	Roller Ø450 mm 1,80m (without frame, without bearing)
2e	506 287	Krümlerwalze Ø450 mm 2,00 m (ohne Lager, ohne Rahmen)
2e	506 287	Roller Ø450 mm 2,00m (without frame, without bearing)
2f	506 289	Krümlerwalze Ø450 mm 2,30 m (ohne Lager, ohne Rahmen)
2f	506 289	Roller Ø450 mm 2,30m (without frame, without bearing)
2g	506 291	Krümlerwalze Ø450 mm 2,60 m (ohne Lager, ohne Rahmen)
2g	506 291	Roller Ø450 mm 2,60m (without frame, without bearing)
2h	506 293	Krümlerwalze Ø450 mm 3,00 m (ohne Lager, ohne Rahmen)
2h	506 293	Roller Ø450 mm 3,00m (without frame, without bearing)

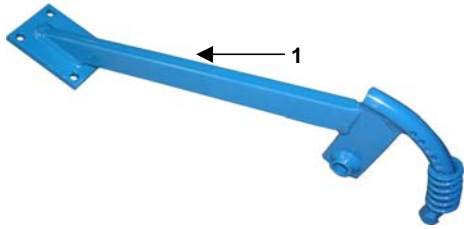

Pos. Art. Nr. Bezeichnung

- 1 080570 Striegelhalter
- 1 080570 Arm
- 2 901618 Mutter M12 DIN 980
- 2 901618 Nut M12
- 3 900970 Bügelschraube M12 x 81 x 110mm
- 3 900970 U-Bolt M12 x 81 x 110mm
- 4 901714 Federstecker 6mm
- 4 901714 R-Clip 6mm
- 5 500080 Druckfeder für Striegelhalter
- 5 500080 Spring for pressure adjustment

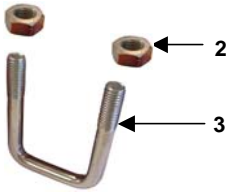

**190803 Krümmlerhalter kpl.
190803 Tine Holder cpl.**

- 6 900198 Krümmlerhalter ohne Bolzen mit Platte
- 6 900198 Lower section of tine holder with plate
- 7 903049 Bolzen 19 x 53 x 74mm
- 7 903049 Bolt 19 x 53 x 74mm

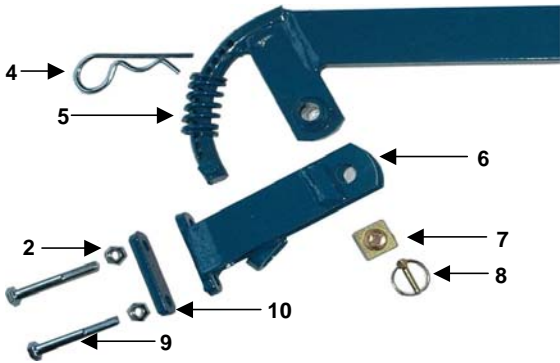

- 8 500055 Klapstecker 6 x 32mm
- 8 500055 Lynch pin 6 x 32mm
- 9 901720 Sechskantschraube M12 x 90mm
- 9 901720 Bolt M12 x 90mm
- 10 632286 Gegenplatte f. Krümmlerhalter 30 x 10 x 95mm
- 10 632286 Plate 30 x 10 x 95mm

**11 wird ersetzt durch 501132
11 replaced by 501132**

- 12 501132 Nachstriegel 13mm neue Variante (ab 02/2006)
- 12 501132 Seedbed tine 13mm new (since 02/2006)

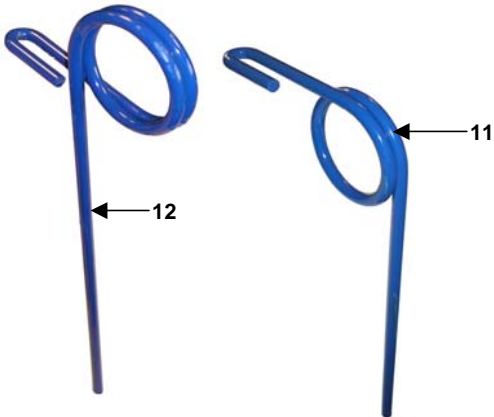

- 13 562240 Befestigungsplatte 40 x 6 x 95mm
- 13 562240 Plate 40 x 6 x 95mm
- 14 562052 Bügelschraube M12 x 51 x 80mm ohne Mutter
- 14 562052 U-Bolt M12 x 51 x 80mm

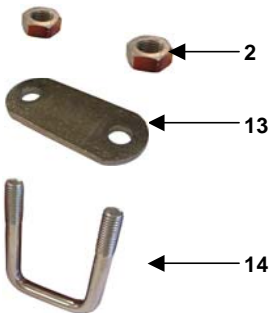

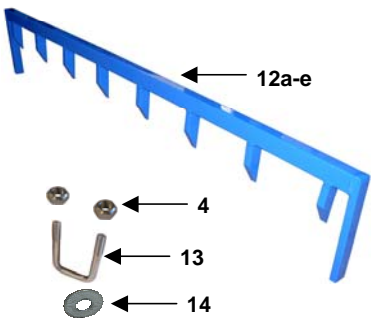
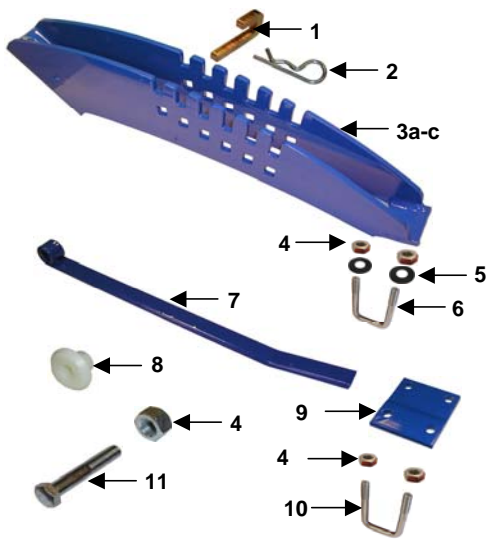

Pos.	Art. Nr.	Bezeichnung
1	904488	Einstellhebel
1	904488	Pin
2	901712	Federstecker 4mm
2	901712	R-Clip 4mm
3a	632416	Striegelhaltebogen DSTS
3a	632416	Bracket DSTS
3b	632414	Striegelhaltebogen STS
3b	632414	Bracket STS
3c	632418	Striegelhaltebogen Krümler 350/450mm
3c	632418	Bracket roller 350/450mm
4	901618	Mutter M12 DIN 980
4	901618	Nut M12
5	901634	U-Scheibe 13mm
5	901634	Washer 13mm
6	904494	Bügelschraube M12 x 31 x 65mm
6	904494	U-bolt M12 x 31 x 65mm
7	904496	Striegelhaltebügel 32x10mm
7	904496	Bracket 32x10mm
8	904452	Lagerbuchse
8	904452	Bush
9	904486	Auflageplatte 120x91x10mm
9	904486	Plate 120x91x10mm
10	562052	Bügelschraube M12 x 51 x 80mm ohne Mutter
10	562052	U-Bolt M12 x 51 x 80mm
11	901579	Sechskantschraube M12x70mm
11	901579	Bolt M12x70mm
12a	632 934	Reiniger STS Walze 7 Ringe
12a	632 934	Wear part 7
12b	632 426	Reiniger STS Walze 8 Ringe
12b	632 426	Wear part 8
12c	632 424	Reiniger STS Walze 9 Ringe
12c	632 424	Wear part 9
12d	632 436	Reiniger STS Walze 11 Ringe
12d	632 436	Wear part 11
12e	632 438	Reiniger STS Walze 12 Ringe
12e	632 438	Wear part 12
13	904494	Bügelschraube M12 x 31 x 65mm
13	904494	U-bolt M12 x 31 x 65mm
14	901634	U-Scheibe 13mm
14	901634	Washer 13mm

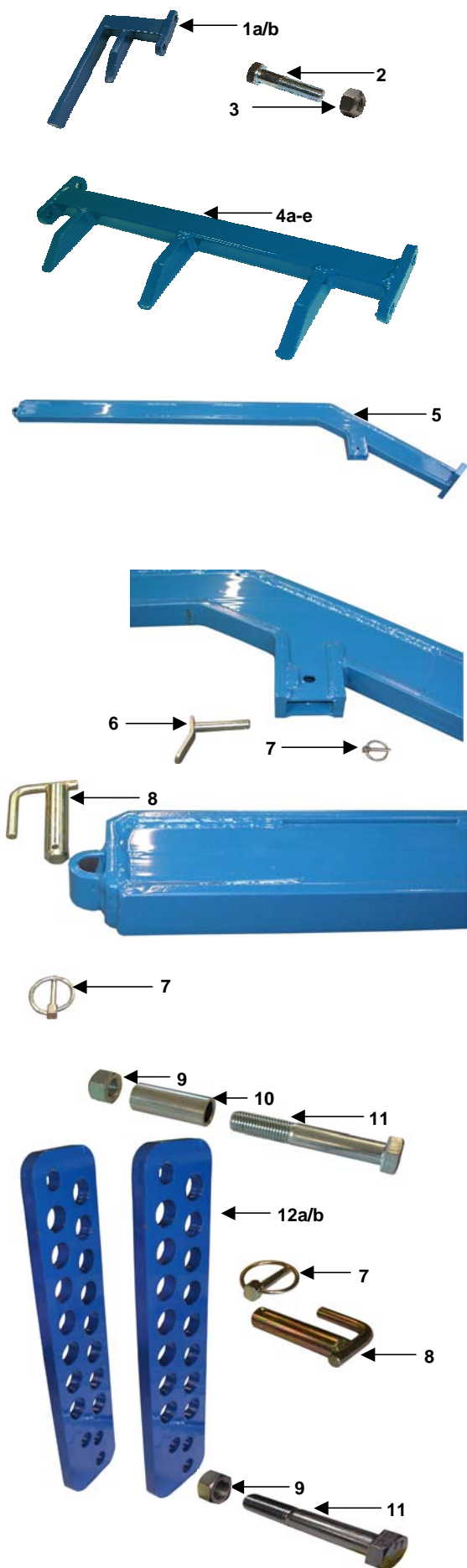

Pos.	Art. Nr.	Bezeichnung
1a	084266	Abstreifer links
1a	084266	Wear part left
1a	084266	Décrottoir gauche
1b	084264	Abstreifer rechts
1b	084264	Wear part right
1b	084264	Décrottoir droite
2	901717	Sechskantschraube M12 x 55mm
2	901717	Bolt M12 x 55mm
2	901717	Vis M12 x 55mm
3	901618	Mutter M12 DIN 980
3	901618	Nut M12
3	901618	Ecrout M12
4a	084272	Abstreifer 2 Ringe
4a	084272	Wear part
4a	084272	Décrottoir 2 bagues
4b	084200	Abstreifer 3 Ringe
4b	084200	Wear part
4b	084200	Décrottoir 3 bagues
4c	084268	Abstreifer 4 Ringe
4c	084268	Wear part
4c	084268	Décrottoir 4 bagues
4d	085210	Abstreifer 5 Ringe
4d	085210	Wear part
4d	085210	Décrottoir 5 bagues
4e	084270	Abstreifer 6 Ringe
4e	084270	Wear part
4e	084270	Décrottoir 6 bagues
5	084234	Anbauarm
5	084234	Arm
5	084234	Bras pour rouleau
6	903713	Bolzen mit Griff 16 x 42 x 56mm
6	903713	Pin 16 x42 x 56mm
6	903713	Broche 16 x 42 x 56mm
7	500055	Klappstecker 6 x 32mm
7	500055	Lynch pin 6 x 32mm
7	500055	Clavette de sécurité 6 x 32mm
8	500008	Bolzen mit Griff 22 x 82 x 103mm
8	500008	Pin 22 x 82 x 103mm
8	500008	Broche 22 x 82 x 103mm
9	901620	Mutter M16 DIN 980
9	901620	Nut M16
9	901620	Ecrout M16
10	632576	Hülse 55x22x3mm
10	632576	Bush
10	632576	Douille
11	901554	Sechskantschraube M16 x 100mm
11	901554	Bolt M16 x 100mm
11	901554	Vis M16 x 100mm
12a	506263	Absteckplatte mit 16 Bohrungen (1 Paar)
12a	506263	Plate (2 pieces)
12a	506263	Plaque (2 pièces)
12b	904856	Absteckplatte lang für DSTS
12b	904856	Plate long DSTS
12b	904856	Plaque DSTS

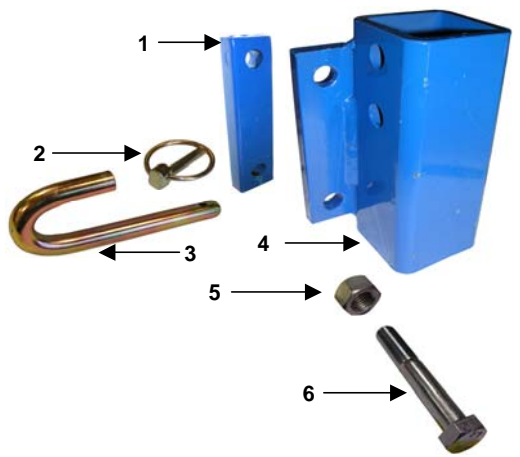

Pos.	Art. Nr.	Bezeichnung
1	632288	Brücke 40 x 15 x 157mm
1	632288	Plate 40 x 15 x 157mm
1	632288	Plaque 40x15x157mm
2	500055	Klappstecker 6 x 32mm
2	500055	Lynch pin 6 x 32mm
2	500055	Clavette de sécurité 6 x 32mm
3	904014	Bolzen
3	904014	Pin
3	904014	Broche
4	506254	Stützradhalter
4	506254	Bracket
4	506254	Jambage de roue de jauge
5	901620	Mutter M16
5	901620	Nut M16
5	901620	Ecrout M16
6	901554	Sechskantschraube M16 x 100mm
6	901554	Bolt M16 x 100mm
6	901554	Vis M16x100mm



7	900694	Stützrad 195/70 R14"
7	900694	Depth wheel 195/70 R14"
7	900694	Roue de jauge
8	190420	Stützradstiel mit 5- Loch-Nabe
8	190420	Support for depth wheel
8	190420	Support de roue de jauge
9	900377	Kugelbundmutter M14 x 1,5
9	900377	Nut M14 x 1,5
9	900377	Ecrout M14x1,5



10	900375	Radbolzen M14 x 1,5
10	900375	Bolt M14 x 1,5
10	900375	Vis M14x1,5



11	900372	Laufgradachse kpl.
11	900372	Axle
11	900372	Essieu

12	562047	Radkappe
12	562047	Hub cap
12	562047	Chapeau d'essieu

13	562050	Splint
13	562050	Pin
13	562050	Goupille

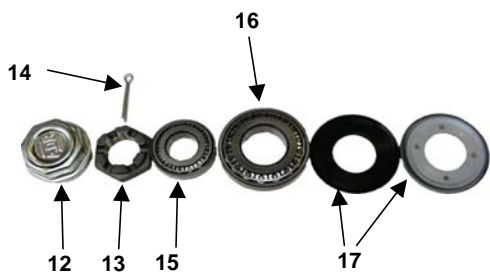

14	562051	Kronenmutter m. Splint
14	562051	Castle Nut with pin
14	562051	Ecrou à créneaux avec goupille
15	562046	Kugellager 30205
15	562046	Bearing 30205
15	562046	Roulement à rouleaux coniques 30205
16	562048	Kugellager 30207
16	562048	Bearing 30207
16	562048	Roulement à rouleaux coniques 30207

17	562059	Dichtung
17	562059	Washer
17	562059	Rondelle



18	903517	Lackfarbe (Sprühdose) 400ml blau
18	903517	Gloss paint (spray) 400ml blue
18	903517	Ripolin (bombe aérosol) 400ml bleu
19	903537	Lackfarbe 1000ml blau
19	903537	Gloss paint 1000ml blue
19	903537	Ripolin 1000ml bleu

Hydraulikplan Grubbermat

Pos.Nr.	Art.Nr.	Artikelbezeichnung	
1	900 114	Zylinder DW 80/40/500/800 für Arbeitsbreite 4,40m und 5,20 m	
	oder		
1	900 116	Zylinder DW 90/45/500/800 für Arbeitsbreite 6,00 m	
	oder		
1	900 117	Zylinder DW 100/50/500/800 für Arbeitsbreite 7,60 m	
2	900 566	Verschraubung x GE-8 L M 18 x 1,5	
3	900 522	H-Schlauch DN6-1SN 500 DKOL/DKOL M 14 x 1,5	
4	900 532	H-Schlauch DN6-1SN 1050 DKOL/DKOL 90° M 14 x 1,5	
5	900 600	T- Stück evT-8 L vormontiert	
6	900 540	H-Schlauch DN6-1SN 2200 DKOL/DKOL M 14 x 1,5	
7	900 620	Schnellverschlußstecker BG 3 M 14 x 1,5	
8	900 568	Verschraubung x GE-8 L 1/4"	
9	900 616	doppelentsperbares Rückschlagventil 1/4"	

